

## RIGHT-OF-WAY (UTILITY) PERMIT APPLICATION PROCEDURES

1. Before any Right-of-Way (ROW) work is performed within the City of Crestwood, a ROW permit application must be submitted for approval. Approval of this application will be granted by the Department of Public Works only if the permit application is completed in its entirety. A Plat Survey and drawing (to scale) of work to be done is required with application and payment. ***Include picture of pavement to be replaced including street, curb, gutter, driveway and sidewalk.***
2. The excavation for pavement (driveway, street, sidewalk, etc.) will require the site to be inspected by the Department of Public Works before the new pavement material is installed. This ensures the new pavement will meet the ROW requirements of the City of Crestwood. Copies of the City of Crestwood pavement restoration requirements are available upon request. To schedule pre-pour and final inspections, please contact the Superintendent of Maintenance at 314-729-4730.  
**NOTE: Any damage to the street, curb, gutter, driveway and sidewalk will need to be repaired or replaced according to the Crestwood Pavement Restoration Requirements.**
3. A Permit Fee, a ROW Management Fee and an Escrow Deposit Fee are required. The amounts of these fees can vary depending upon the size and type of excavation. The Escrow Fee will be deposited immediately. The Escrow Deposit Fee will be refunded after final inspection of the site has been completed to the satisfaction of the City Inspector. *An Escrow Deposit is not required for utility companies or government agencies.*
4. A Contractor's Business License is required for all general contractors that do not have a CRESTWOOD BUSINESS LICENSE.
5. Any private contractor applying for a permit to excavate in the street must provide the City with a \$5,000 bond or have on file, a \$50,000 bond, guaranteeing their work for a period of two (2) years. In addition, the permit applicant must submit a Certificate of Insurance in the amount of \$2,000,000 in the aggregate with the City of Crestwood named as additional insured.
6. Should the applicant have any questions regarding the Right-of-Way Permit Application Procedures, please contact the Department of Public Works at 314-729-4720.



Department of Public Works
One Detjen Drive | Crestwood, MO 63126

Right-of-Way (UTILITY) Permit Application

Emergency: Yes [ ] No [ ]

Application Date: \_\_\_\_\_

WORK SITE ADDRESS: \_\_\_\_\_

Owner Name & Address: \_\_\_\_\_

Phone: \_\_\_\_\_

Applicant Name & Address: \_\_\_\_\_

Phone: \_\_\_\_\_

Location of Work: Parkway [ ] Pavement/Street [ ] Sidewalk [ ] Driveway [ ] Apron [ ] Grass [ ]

Type of Work (Check applicable Items):

[ ] Driveway Replacement [ ] Sidewalk Replacement [ ] Street Excavation [ ] Parkway Excavation

[ ] Utility Repair/Installation [ ] Cable Bore [ ] Gas Tap [ ] Water Tap

[ ] Sewer Lateral Repair [ ] Other: \_\_\_\_\_

NOTE: Include picture of pavement to be replaced including street, curb, gutter, driveway & sidewalk. Any damage to the street, curb, gutter, driveway and sidewalk will need to be repaired or replaced according to the Crestwood Pavement Restoration Requirements.

Description of Work: \_\_\_\_\_

IN CONSIDERATION FOR THIS PERMIT, THE PERMITEE AGREES TO INDEMNIFY AND SAVE HARMLESS THE CITY OF CRESTWOOD, MISSOURI FROM AND AGAINST ALL CLAIMS, SUITS, DAMAGES, COSTS, LOSSES AND EXPENSES IN ANY MANNER SO RESULTING FROM, ARISING OUT OF, OR CONNECTED WITH THIS PERMIT. PERMITEE ALSO AGREES THAT ALL WORK AUTHORIZED BY THIS PERMIT SHALL BE CONDUCTED IN COMPLIANCE WITH THE RULES AND REGULATIONS FOR WORK WITHIN THE CITY RIGHT-OF-WAY, IN ACCORDANCE WITH CHAPTER 24 SECTIONS 24-63 THRU 24-97 OF THE CRESTWOOD MUNICIPAL CODE. THIS PERMIT EXPIRES ON THE PERMIT END DATE STATED BELOW UNLESS AN EXTENSION IS AUTHORIZED AS PROVIDED BY CODE. PERMITEE AGREES TO CONTACT MISSOURI ONE-CALL TO OBTAIN UNDERGROUND UTILITY LOCATIONS PRIOR TO STARTING EXCAVATION OF RIGHT-OF-WAY. FAILURE OF THE APPLICANT TO CALL FOR THE FINAL INSPECTION WITHIN ONE YEAR OF THE ISSUANCE DATE OF THE PERMIT SHALL RESULT IN THE ESCROW DEPOSIT BEING FORFEITED BY THE APPLICANT. PLEASE NOTE: A CONTRACTOR'S BUSINESS LICENSE IS REQUIRED FOR ALL CONTRACTORS THAT DO NOT HAVE A CRESTWOOD BUSINESS LICENSE.

Applicant/Contractor's Signature: \_\_\_\_\_ Print Name: \_\_\_\_\_

Pavement Restoration Detail sheets available upon request. Please contact Brian Hibdon at 314-729-4730 or Doug Wilson at 314-729-4737 to schedule pre-pour \_\_\_\_\_ and final \_\_\_\_\_ inspections of pavement restoration.

EMAILED TO BRIAN/DOUG: \_\_\_\_\_ FINAL INSPECTION DATE AND SIGNATURE \_\_\_\_\_

\*\*\*\*\*

OFFICE USE ONLY

PERMIT #: \_\_\_\_\_

CONTRACTOR'S BUSINESS LICENSE #: \_\_\_\_\_

PERMIT AND RESTORATIONS FEES (NON-REFUNDABLE):

Permit Fee: \$ 80.00 \$ 80.00
ROW Management Fee: 15.00 or 82.00
TOTAL: \$ 95.00 \$162.00

ADDITIONAL REQUIREMENTS:

Performance Bond Required: [ ] Yes [ ] No
Liability Insurance Required: [ ] Yes [ ] No

[ ] Paid by Cash [ ] Paid by Check # \_\_\_\_\_ Date Paid: \_\_\_\_\_ Rec'd by: \_\_\_\_\_

ESCROW DEPOSIT AMOUNT: \$ \_\_\_\_\_ OWNER OF ESCROW: [ ] Home Owner or [ ] Contractor

[ ] Paid by Cash [ ] Paid by Check # \_\_\_\_\_ Date Paid: \_\_\_\_\_ Rec'd by: \_\_\_\_\_

Approved By: \_\_\_\_\_ Title: \_\_\_\_\_ Date: \_\_\_\_\_

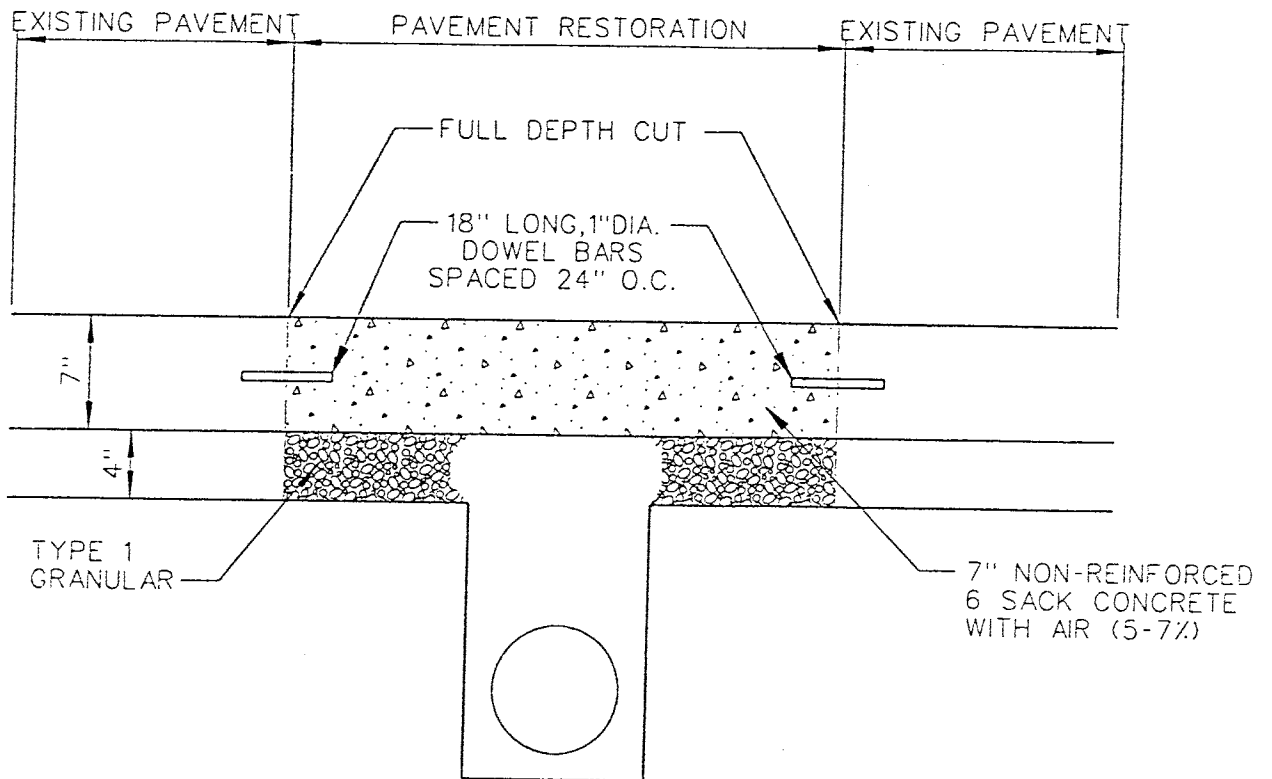

NOTES:

- 1.) FULL PANEL REPLACEMENT IS REQUIRED UNLESS OTHERWISE SPECIFIED BY DEPARTMENT OF PUBLIC WORKS.

REV 10-04



CONCRETE PAVEMENT RESTORATION

ATTACHMENT A

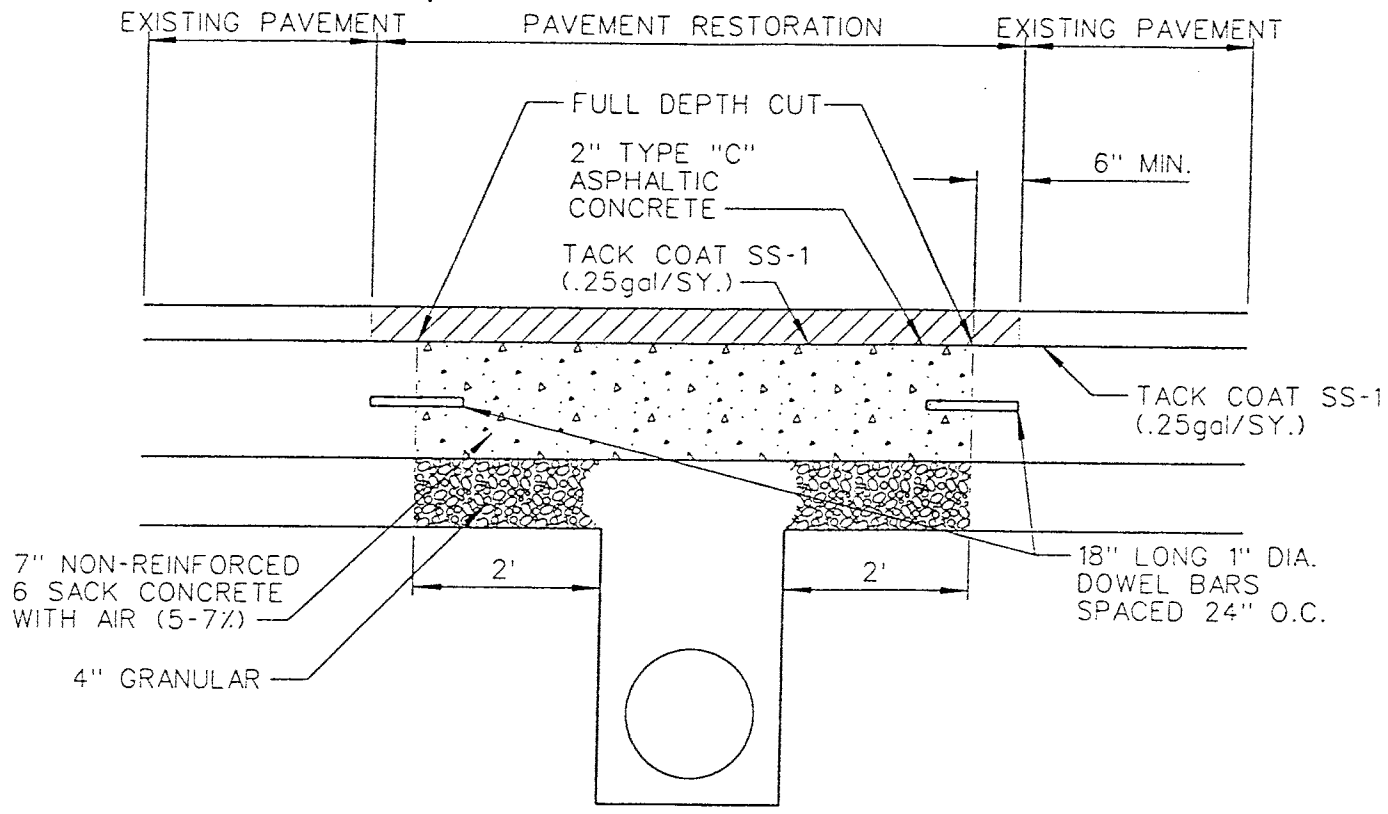

REV 10-04



CONCRETE PAVEMENTS WITH ASPHALT OVERLAY

ATTACHMENT B

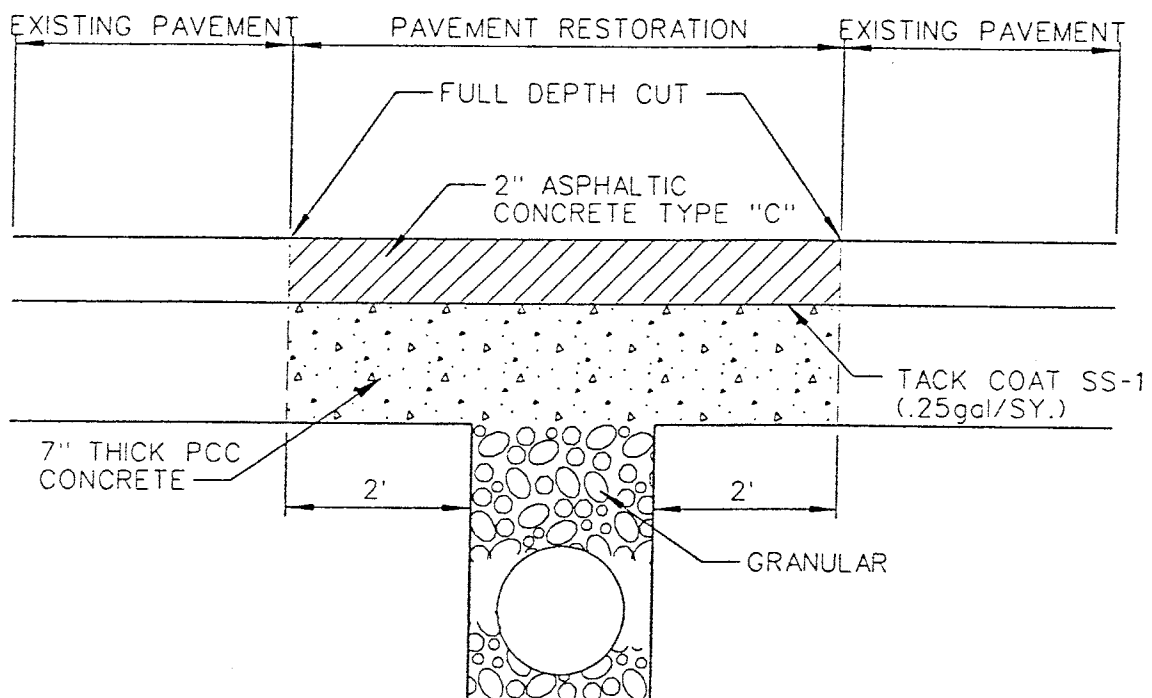

REV 10-04



**FULL DEPTH ASPHALT RESTORATION**  
 FULL DEPTH PAVEMENT REPLACEMENT

**ATTACHMENT C**

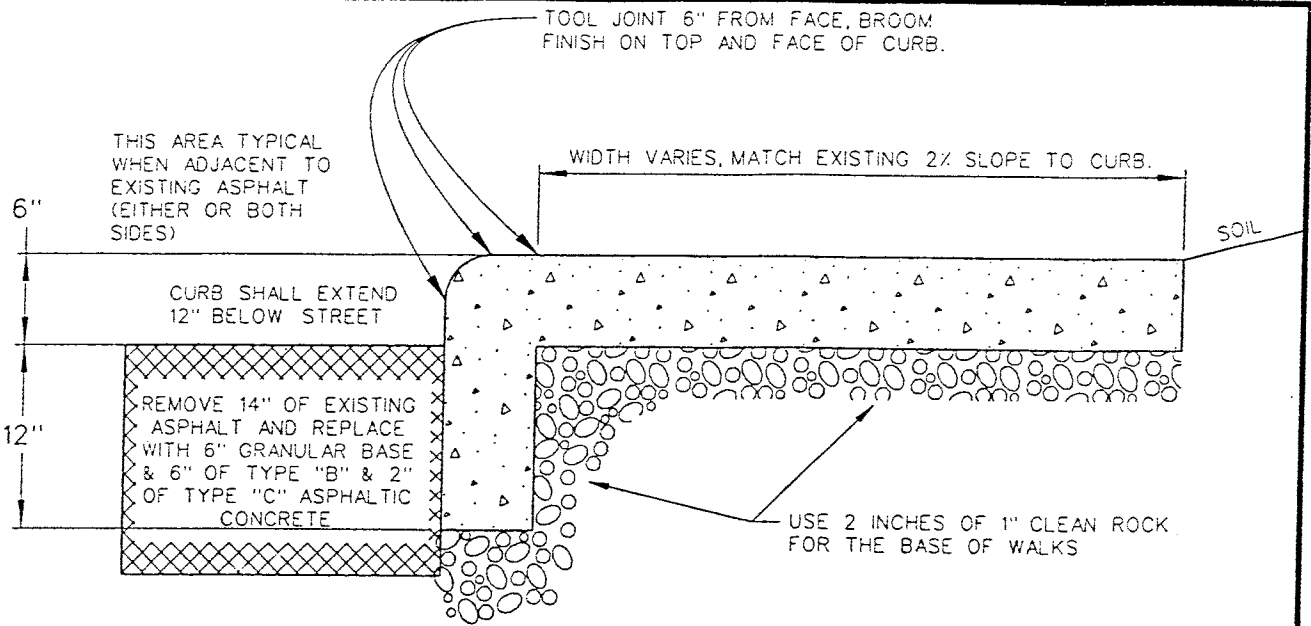

**INTEGRAL CURB AND SIDEWALK DETAIL**

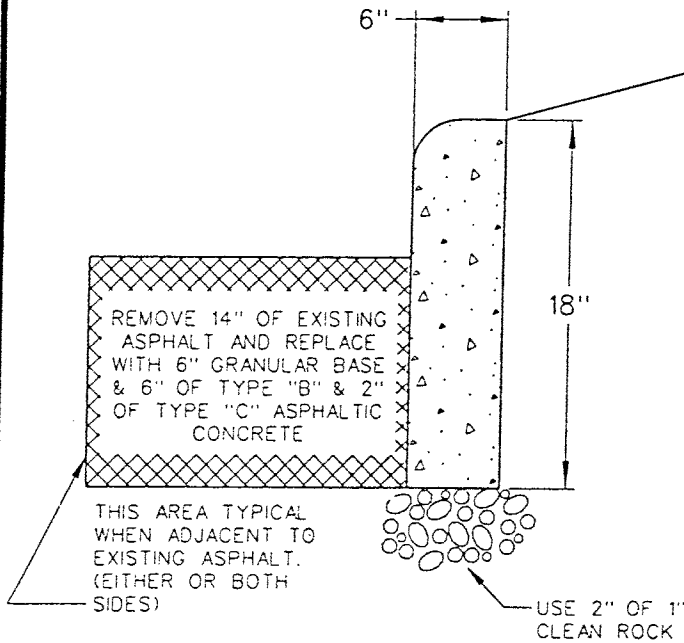

**VERTICAL CURB**

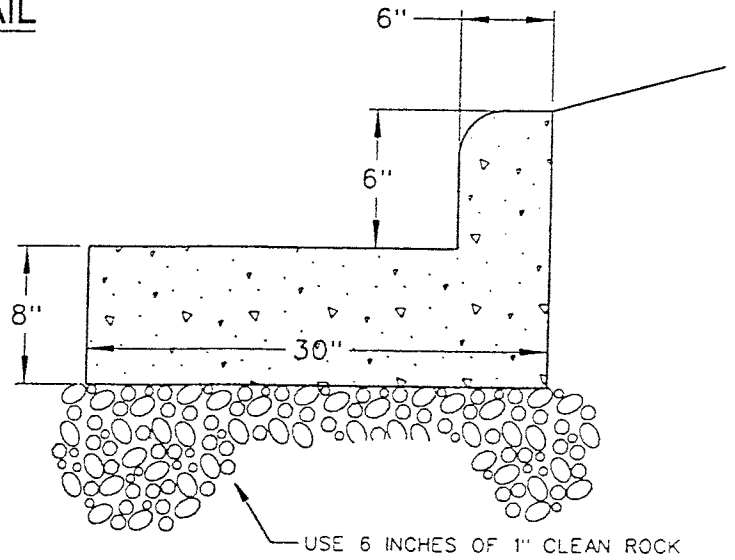

**CONCRETE CURB AND GUTTER**

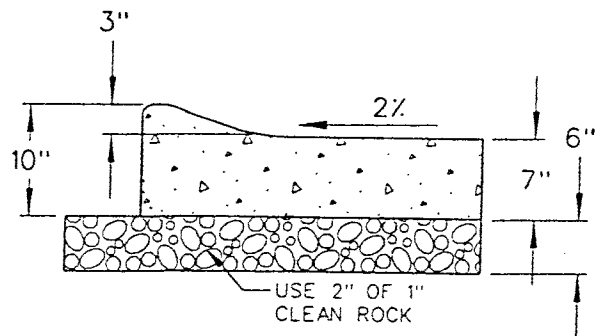

**INTEGRAL ROLLED CURB DETAIL**

REV 10-04



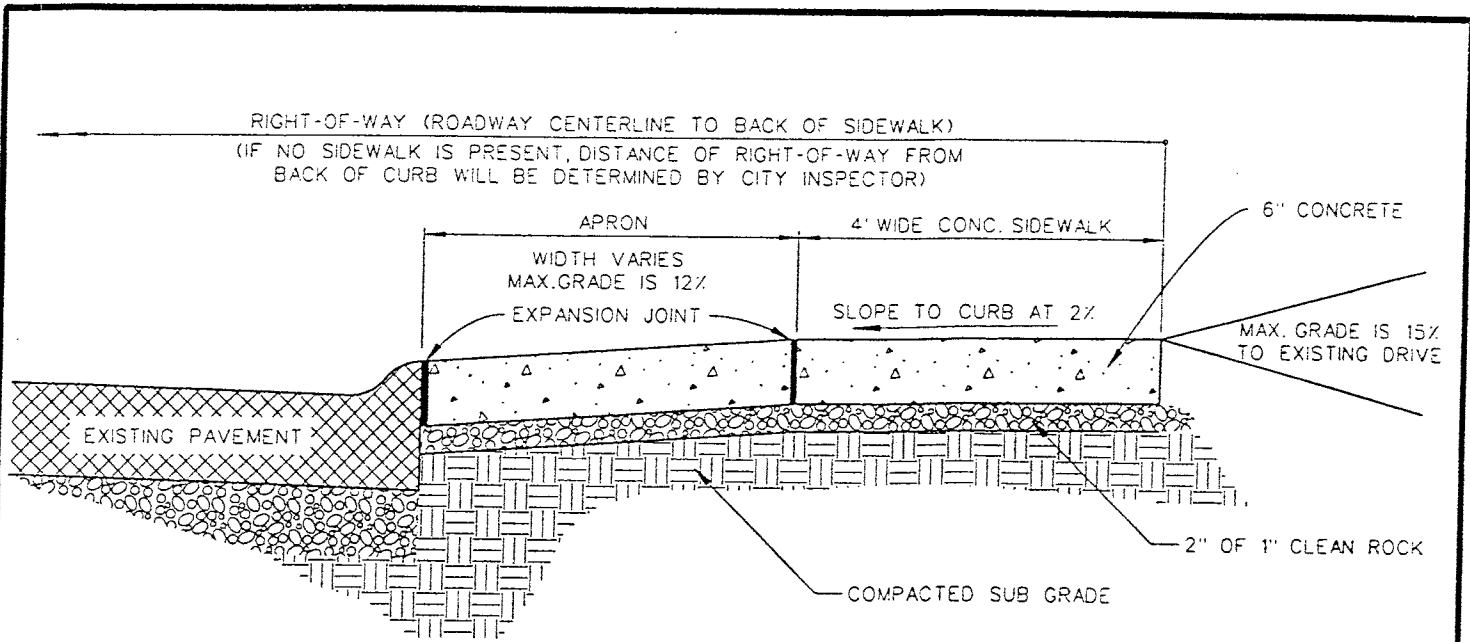

TYPICAL DRIVEWAY APRON

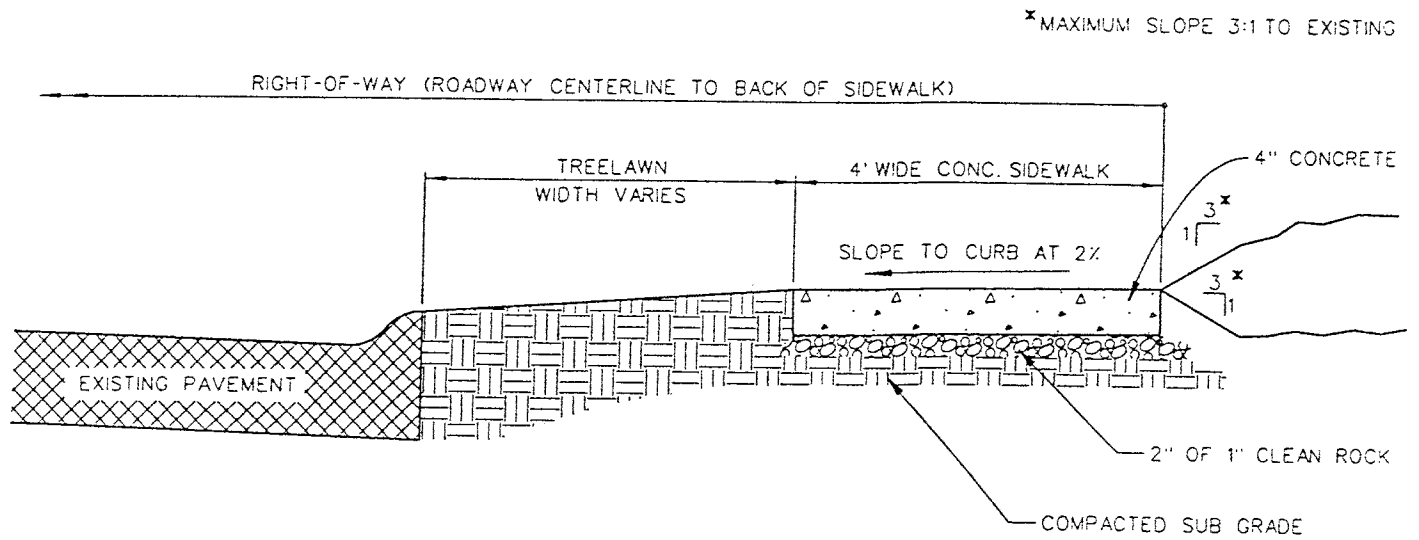

TYPICAL SIDEWALK WITH TREELAWN

REV 10-04

